

INSTRUCTION MANUAL

CS-350V

**MetalMaster Cold Saw, Includes Stand (415V)
160 x 90mm**



S830

Table of Contents

1 SAFETY REGULATIONS.....	2	8.1 Disk Head	10
1.1 General Safety Advice	2	8.2 Adjusting the Mitering Lock Lever... ..	10
1.2 Blade Guard Safety.....	2	8.3 Changing the Disk.....	10
1.3 Emergencies	2	8.4 Cleaning and Accessing the Coolant System	10
2 MACHINE DIMENSIONS	2	8.5 Troubleshooting the inverter	11
3 TECHNICAL CHARACTERISTICS.....	3	8.6 Common Problems and Solutions ..	11
3.1 General Characteristics.....	3	9 THE OPERATION CYCLE	14
4 TRANSPORTING THE MACHINE	3	9.1 Miter Angle.....	14
5 GETTING TO KNOW YOUR MACHINE .	3	9.2 Vise Operation	14
5.1 Disk Head Assembly	3	9.3 Loading the Work-piece	15
5.2 Machine Base	4	9.4 Setting Cutting Length	15
5.3 Vice	4	9.5 Operation Cycle	15
5.4 Support Roller	4	10 ROUTINE AND SPECIAL MAINTENANCE	16
5.5 Stand.....	4	10.1 Daily Maintenance	16
5.6 Coolant Pump	4	10.2 Weekly Maintenance.....	16
6 GETTING STARTED	5	10.3 Monthly Maintenance.....	17
6.1 Minimum Requirements for Housing the Machine	5	10.4 Six-Monthly Maintenance.....	17
6.2 Anchoring the Machine	5	10.5 Oils for Lubricating Coolant.....	17
6.3 Assembly and Setup	5	10.6 Oil Disposal.....	17
6.4 Electrical Connection of the Machine	8	10.7 Special Maintenance.....	17
7 RECOMMENDATIONS AND ADVICE	8	11 TROUBLESHOOTION	18
7.1 General Advise Before Using the Machine	8	11.1 Blade and cut diagnosis.....	18
7.2 Operator Position	8	12 WIRING DIARAM AND PARTS LIST .	21
7.3 Deactivating the Machine.....	9	12.1 WIRING DIARAM.....	21
7.4 Dismantling	9	12.2 PARTS LIST	22
8 ADJUSTING THE MACHINE	10		

1 SAFETY REGULATIONS

This machine complies with the national and local accident prevention regulations. Improper use and/or tampering of the machine will relieve the manufacturer of all responsibility.

1.1 General Safety Advice

- Always wear suitable eye protection.
- Always disconnect the machine from the power source before changing the saw blade/cutting disk, or performing any maintenance work.
- Never expose your hands or limbs to the cutting area while the machine is operating.
- Do not shift the machine while in operation.
- Do not wear, gloves, very loose or long clothing, long and loose sleeves, bracelets, chains, neck ties; or any other object that could get caught in the machine during operation
- Tie back long hair.
- Keep the work area free of equipment, tools or any other object.
- Focus on one task at a time
- Keep your hands free; do not carry too many objects in your hands.
- Keep your hands clean.
- When the machine is not in use, the saw blade should not be moving.

1.2 Blade Guard Safety

- The blade guard is a self –adjusting cover that prevents contact with the blade. Never use the machine without the blade guard.
- Never handle blade guard while the blade is running.

1.3 Emergencies

In the event of incorrect operation or dangerous conditions, the machine may be stopped immediately by pressing the emergency stop button. This will shut off the machine and will require resetting of the emergency stop button.

Note: Resetting of machine operation after each emergency stop is achieved by reactivating the specific restart button.

2 MACHINE DIMENSIONS

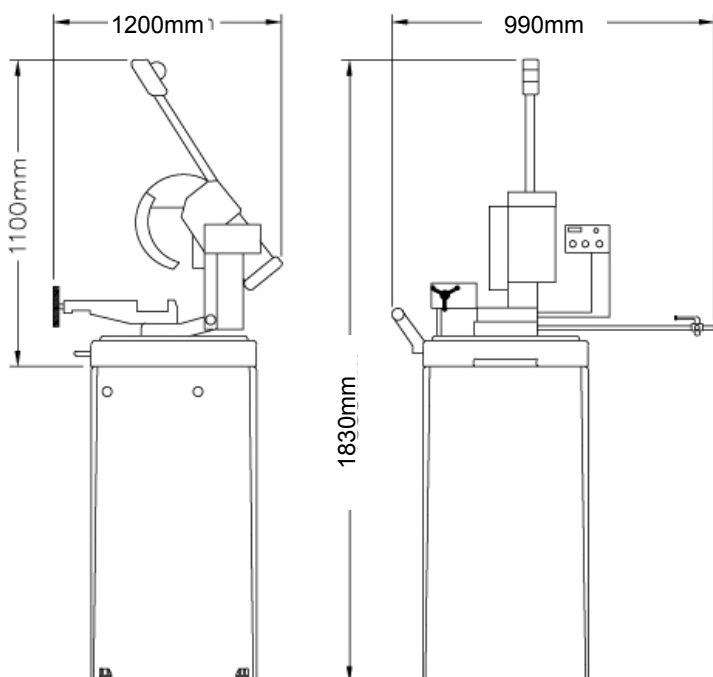

3 TECHNICAL CHARACTERISTICS

3.1 General Characteristics

Cutting Capacity	●	○	□	▭
0°	85mm 3.5"	120mm 4.7"	105 x 105mm 4" x 4"	160 x 90mm 6.3" x 3.5"
45°	75mm 3"	100mm 4"	85x 85mm 3.5" x 3.5"	85 x 70mm 3.5" x 2.8"
Main Motor	3 HP / 4pole			
Spindle Speed	24~120RPM			
Saw Blade	HSS 2.5mm x 32 x Φ 350 mm			
Maximum Vise Opening	170 mm 4.7"			
Cooling Pump	1/8 HP			
Coolant tank	5 L			
Machine Weight (KGS)	250 kgs (with stand)			
Machine Dimensions (with stand) L x W x H	1200 x 990 x 1720mm 47" x 39" x 67.7"			
Stand Dimensions	600 x 580 x 720 mm 23.6" x 22.8" x 28.3"			

4 TRANSPORTING THE MACHINE

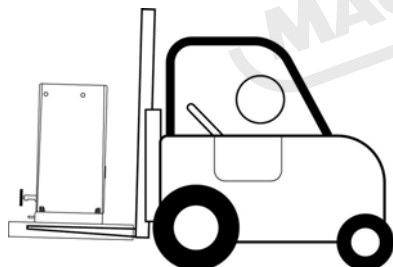

When transporting in its own packaging, use a forklift truck or hand trolley.

5 GETTING TO KNOW YOUR MACHINE

5.1 Disk Head Assembly

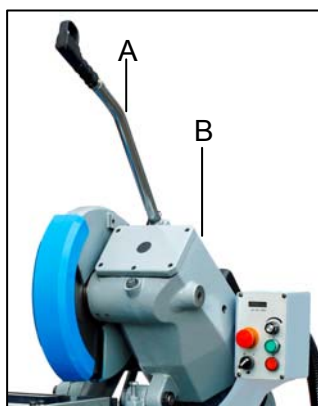

The section of the machine composed motor, gear transfer system, disc or blade, and control handle.

A. Control Lever

A long angled lever with a handle grip and trigger switch for starting, raising, and lowering the disk head

B. Transfer Case

The central part of the assembly, housing the gear system and oil tank.

5.2 Machine Base

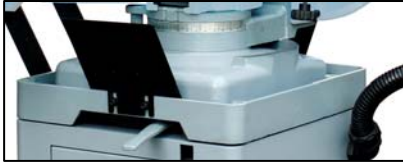

A heavy cast iron structure that supports the miter system, vise system, and head assembly.

5.3 Vice



A clamping system that provides the basic support and security for the work material. Operations are conducted by hand-wheel, which opens and closes the vise jaws. The clamping vise can be adjusted forward and backward to clamp workpiece of various sizes.

5.4 Support Roller



A Device that support longer sized material. The roller assists stock moving through the vise.

5.5 Stand



Support structure for the Machine Head Assembly, Machine Base, and Vise system. The stand also stores electrical control box at the front and coolant pump at rear.

5.6 Coolant Pump



Found within the machine stand, the coolant pump is a self contained system that includes a tank, pump motor, filters and hoses.

6 GETTING STARTED

- Make sure that the electrical supply and the machine’s voltage are the same. Refer to the identification plate on the motor for the correct voltage.
- Use a good quality grounded electrical system.
- All internal and/or internal operations, maintenance or repairs, must be performed in a well-lit area or where there is sufficient light from extra sources so as to avoid the risk of even slight accidents.

6.1 Minimum Requirements for Housing the Machine

The Main voltage and frequency complying with the requirements for the machine’s motor.
 Environment temperature from -10°C to $+50^{\circ}\text{C}$.
 Relative humidity not over 90%.

6.2 Anchoring the Machine

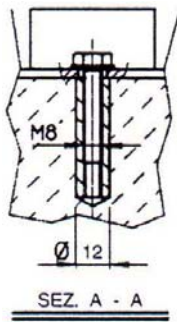

- Position the machine on a firm and level concrete floor.
- Maintain a minimum distance of 800mm from the wall to rear of the machine.
- Anchor the machine to the ground, as shown in the diagram, using screws and expansion plugs or sunken tie rods that connect through holes in the base of the stand.
- Ensuring that it is sitting level.

6.3 Assembly and Setup

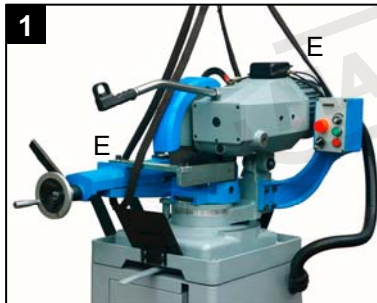

Positioning the machine

Please follow the instruction bellow when unpacking the machine from the package.

- Take out the accessory box from the rear for assembling some parts later.
- Take out the machine from the package to the intended working location by hoisting with the belts. The load capacity is about 300kgs at point E.
- Method one: Use a sling. Carefully wrap the sling (E) around the collar of the moveable jaw and motor mount.
- Method two: Using lift rings. Attach lifting rings to three points on the base of the machine. Attach a three-point sling with grab or sling hooks to the lift rings.

Initial Cleaning

- Machine is shipped with rustproof oil coating. Clean the rust proof oil coating from all exposed metal surface. Then apply oil / grease.



- The stand of the cold saw has four mounting holes, two holes on each side of the stand(). The cold saw should be kept level and rest solidly on the floor.
- Please refer to the anchoring section above. When securing the stand to the floor, apply even torque to the fasteners to prevent distortion of the stand.

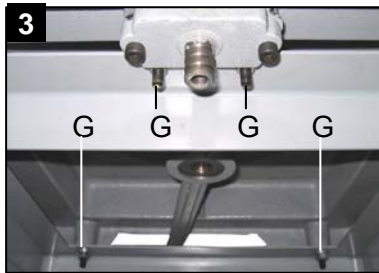

- The machine has been fixed on the stand already to use. Giving the picture by appearing the fixing points for reference.
- Align the four setscrews (G) on the underside of the machine base to their corresponding holes in the stand.
 - Direct the setscrews (G) into their matching holes while lowering the machine onto the stand.
 - Secure the machine onto the stand using three nuts to the exposed setscrews.

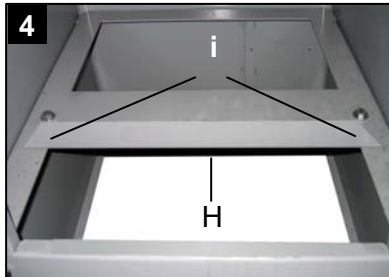

- The coolant tank platform has been fixed on already. The following is for your reference.
- Insert platform (H) to the interior of the machine stand.
 - Align the platform holes (i) to the screw holes (i) on the interior of the machine stand.
 - Apply an M8x18x2, washer to each of the 2 M8x12 screws.
 - Secure the platform (H) to the stand.

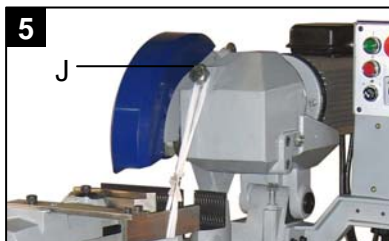

- Use a wrench to unscrew a M20 X 40 hex head screw (J) from the oil fill hole (J).

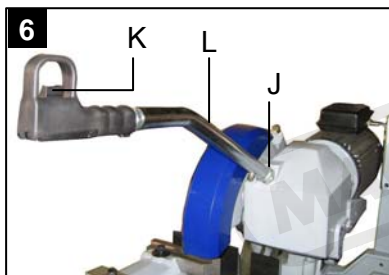

- Attach the control handle to the head assembly.
- Insert the threaded end of the control handle into the gear oil fill hole (J).
 - Turn the control handle (L) along the shaft to screw in the control handle (L) until a tight fit.
 - Align the handle (L) so that the trigger switch (K) point up. (Refer to image)

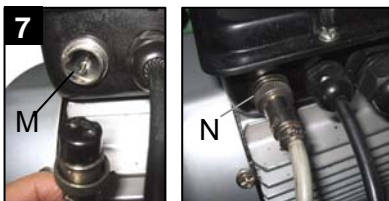

- Connect the electric wire with the motor.
- Locate the open socket (M) at the side of the electrical box on the top of the motor.
 - Plug in the control handle cable into the open socket (M).
 - Use a wrench to screw in the cable connector nut (N).

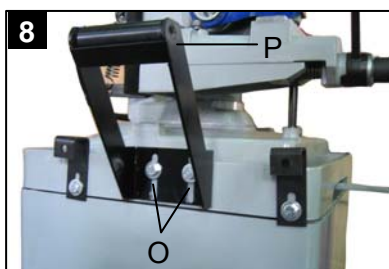

- Attach the support roller to the left side of the base.
- Place the support roller (P) up next to the machine base.
 - Align the 2 slots (O) in the base of the support roller with the matching screw holes on the base of the machine.
 - Apply an M10 washer for each of 2 M10x25 hex head bolts.
 - Loosely screw the hex head bolts into the aligned slot (O) and holes.
 - Adjust the height of the support roller (P). Place a level across the mouth of the vise and support roller. If a long level is not available, use a straight bar or piece of material then place a small level on top. Raise or lower the support roller until level.
 - Secure the support roller (P) into place. Use a wrench to tighten down the 2 hex head bolts.



Attach the bar stop to the vise.

- Insert the thread end of the long rod (R) into the side of the vise.
- Turn the long rod clockwise until snug.
- Use a hex wrench 5mm to lock the screw M12x10 (Q) on the sleeve counter-clockwise, so that bar stop unit is secure.

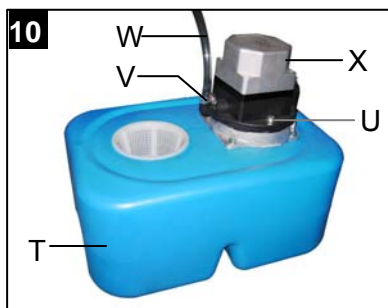

Assemble the coolant tank

- Insert the coolant pump (X) into the coolant tank (T).
- Apply an M6 washer to each of 2 M6x20 screws (U).
- Secure pump (X) to tank (T) with prepared screws (U).
- Place the hose clamp (V) onto the 0.375" flow tube (W).
- Connect the flow tube (W) to the hose connector (V).
- Use a flat head screwdriver to tighten the hose clamp (V).

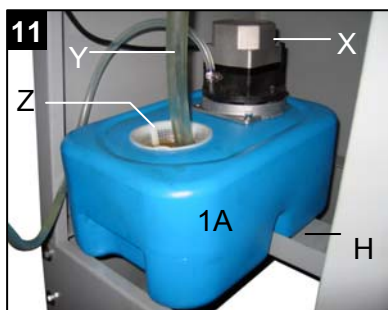

Install the coolant tank

- Orient the coolant pump (X) towards the rear opening of machine stand.
- Place the coolant tank (1A) onto the coolant platform (H). The coolant tank (1A) contains a divider that forms a trough in the bottom of the tank. This trough fit over the vertical lip of the coolant platform (H).
- Insert one end of the 0.5" drain hose (Y) onto the hose connector (1B) on the underside of the machine base.
- Place the other end into the insert (Z) of the coolant tank (1A).

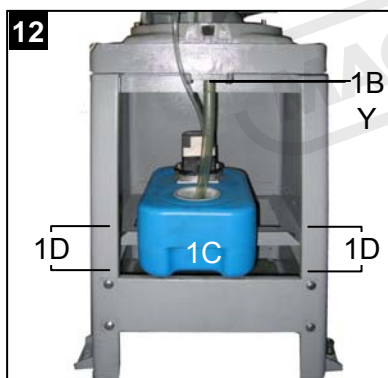

Attach the rear plate to the back of the stand.

- Place rear plate (1C) across the back of the machine stand.
- Align the plate holes (1D) with the set of 4 holes towards the top of the machine stand.
- Apply an M8 washer to each of 4 M8x25 screws.
- Secure with 4 screws and washers.



Install the splash plates

- Insert a splash plate (1E) onto the front sidewall of machine base.
- Align the 2 slots (1F) in the base of the splash plate with the matching screw holes on the machine base.
- Apply a washer for each of 2 hex socket head screws M8x20.
- Loosely screw the socket hex head screws into the aligned slot (1F) and holes.



- Adjust the splash plate (1E) to the proper position and tighten down the screws to secure.
- Insert a longer one of splash plate (1G) onto the rear sidewall of the machine base. This plate need not be secured with screws to allow free movement or convenient removal.

6.4 Electrical Connection of the Machine



- Make sure whether the voltage of the acquired machine is 220V/ 1 phase or (220V,380V,400,440V)/ 3 phase prior to connection.
- The control electrical box is located at the front of the stand with a latching door.
- The power connection cable is at the rear of the electrical box as shown in the picture (6.4 -1).
- This machine uses an inverter to change the speed rate from 24~120rpm. Please refer to the information in front of the window on the control panel.



If the machine cannot be operated after wires have been connected, please check the following items:

1. The Emergency switch is released.
2. The door of the electrical cabinet is properly closed and switched ON (locked).
3. Refer to the Table of Error Codes for the inverter (8.6).

7 RECOMMENDATIONS AND ADVICE

7.1 General Advise Before Using the Machine

- This machine is designed to cut metal construction materials of different shapes and profiles. The materials may be required for fabrication workshops, machinist shops, and general construction work.
- Limit the machines use to a single operator.
- To obtain good running-in of the machine it is advisable to start using it at intervals of about half an hour. This operation should be repeated two or three times, after which the machine may be used continuously.
- Always check that the workpiece is securely clamped and that long pieces are suitably supported.
- Do not use a disk size that is outside the limits of the machine specifications.
- Immediately release the start/run/trigger button if the disk should get stuck in a cut. Switch off the machine before raising the machine head. Then open the vise and remove the workpiece. Lastly, check the disk teeth for any damage. If any of the teeth are broken, replace the saw blade.
- Before carrying out any repairs of the machine, consult a technician.

7.2 Operator Position

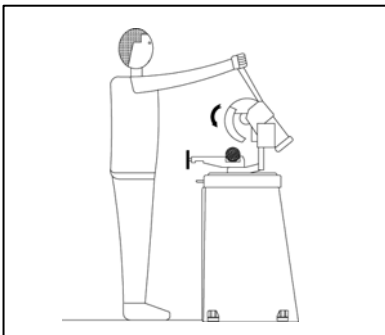

The operator should stand in front of the machine using a single hand to grip the control handle.

7.3 Deactivating the Machine

If the machine is to be inactive for a long period, prepare the machine as follows:

- Detach the plug from the electric supply panel
- Release the head return spring
- Empty the coolant tank
- Carefully clean and grease the machine
- If necessary, cover the machine.

7.4 Dismantling

General rules

Before disposing of the machine, the machine should be broken down and separated into the 3 categories as follows:

- Cast iron or ferrous materials: These materials should be of single composition, without combination or attachment to other types of materials. This is a recyclable material. The materials may be sent to metal scrap and recycling centers.
- Electrical components: This includes cables and electronic parts (magnetic cards, etc.). These materials may be considered as urban waste. Give the materials to your local public waste disposal service.
- Old mineral, synthetic and/or mixed oils: Blend oils and greases are special refuse. Have these collected by a service specializing in oil disposal.

Note: Standards and legislation for waste disposal is in a state continuous change and evolution. The user must be informed of current regulation for waste disposal of machine tools, as they may differ from those described above. They are to be considered as general guideline.



8 ADJUSTING THE MACHINE

BEFORE PERFORMING THE FOLLOWING OPERATIONS, THE ELECTRIC POWER SUPPLY AND THE POWER CABLE MUST BE COMPLETELY DISCONNECTED.

8.1 Disk Head

If excessive axial play is found on the hinge, it will be sufficient to tighten the screws. Pay attention and avoid making the joint too tight.

8.2 Adjusting the Mitering Lock Lever

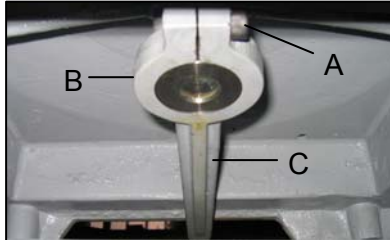

The lock lever may require adjustment when the lever is limited by the machine base and it fail to adequately secure the miter angle for machine head. If there is insufficient brakeage of the lock lever:

- Loosen screw (A)
- Support the bushing (B) so that it does not drop in position.
- Pivot the lever (C) to unlock side to allow more range of motion.
- Then tighten the screw (A).

8.3 Changing the Disk

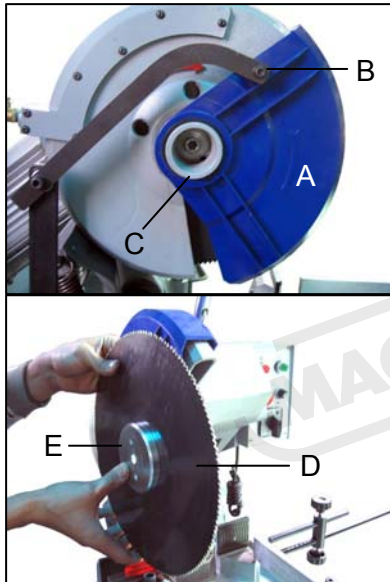

To changed the disk:

- Release the mobile guard (A) by removing the hex socket screw (B).
- Rotate the mobile guard (A) back.
- Place a block of wood into the vise.
- Lower the machine head to rest the cutting disk or saw blade on the block of wood.
- Use a hex wrench to remove the hex socket screw (C),
- Rotate the disk in the clockwise direction to loosen it (because it has a left-handed thread).
- Remove the disk or blade (D) and flange (E) from the head assembly.
- Slip off the flange (E) from the disk (D).
- Place the flange onto the replacement disk or blade (D).
- Continue the replacement of the disk in reverse order of removal of the disk.

8.4 Cleaning and Accessing the Coolant System

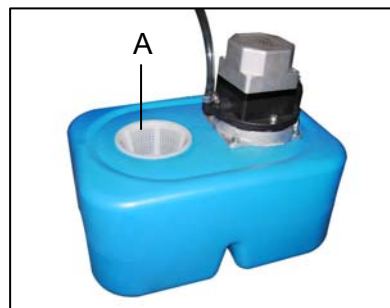

- Pull out the drain hose from the filter (A).
- Pull out the coolant tank from the coolant platform in the stand.
- Remove the filter (A) from the tank
- Pour out the coolant
- Wash out the dirt and debris.
- Replace the filter (A).
- Fill with coolant solution of 1:10 ratio of coolant to water
- Replace the coolant tank in reverse order of removal.

8.5 Troubleshooting the inverter

Troubleshooting the inverter

Prior to operating all electronic parts, the following aspects should be taken into consideration first

Note: Only eligible and qualified personnel can make electronic adjustments.

1. Disconnect machine from power supply.
2. Electronic parts are extremely sensitive, do not use hands or metal tools to remove or install such parts.
3. As remaining voltage still exists in the capacitor even after the electric current has been cut off, wait until the light disappears from the lighted display completely before proceeding with any work to prevent any accidents or hazards from occurring.
4. Pay close attention to the electronic circuit board so that they are free from any defects.
5. Never connect the alternating current directly to the output connector (U/V/W) of the speed adjuster. The electronic self-diagnosis program can notify you of situations like motor overloading and too low or too high voltage, etc. When the program detects an error, the machine will stop immediately and such error will be displayed on the inverter's digital display. Follow the solutions to correct any errors. Close the electrical cabinet and connect machine to power supply.
6. Wait 5 seconds after a fault has been cleared before performing reset via keypad of input terminal.

8.6 Common Problems and Solutions

Fault Name	Fault Descriptions	Corrective Actions
OC	Over current Abnormal increase in current.	<ol style="list-style-type: none"> 1. Check if motor power corresponds with the AC motor drive output power. 2. Check the wiring connections to U/T1, V/T2, W/T3 for possible short circuits. 3. Check the wiring connections between the AC motor drive and motor for possible short circuits, also to ground. 4. Check for loose contacts between AC motor drive and motor. 5. Increase the Acceleration Time. 6. Check for possible excessive loading conditions at the motor. 7. If there are still any abnormal conditions when operating the AC motor drive after a short-circuit is removed and the other points above are checked, it should be sent back to manufacturer.
OU	Over voltage The DC bus voltage has exceeded its maximum allowable value.	<ol style="list-style-type: none"> 1. Check if the input voltage falls within the rated AC motor drive input voltage range. 2. Check for possible voltage transients. 3. DC-bus over-voltage may also be caused by motor regeneration. Either increase the Decel. Time or add an optional brake resistor (and brake unit). 4. Check whether the required brake power is within the specified limits.

Fault Name	Fault Descriptions	Corrective Actions
OH1 OH2	Overheating Heat sink temperature too high	<ol style="list-style-type: none"> 1. Ensure that the ambient temperature falls within the specified temperature range. 2. Make sure that the ventilation holes are not obstructed. 3. Remove any foreign objects from the heatsinks and check for possible dirty heat sink fins. 4. Check the fan and clean it. 5. Provide enough spacing for adequate ventilation. (See chapter 1)
LU	Low voltage The AC motor drive detects that the DC bus voltage has fallen below its minimum value.	<ol style="list-style-type: none"> 1. Check whether the input voltage falls within the AC motor drive rated input voltage range. 2. Check for abnormal load in motor. 3. Check for correct wiring of input power to R-S-T (for 3-phase models) without phase loss.
OL	Overload The AC motor drive detects excessive drive output current. NOTE: The AC motor drive can withstand up to 150% of the rated current for a maximum of 60 seconds.	<ol style="list-style-type: none"> 1. Check whether the motor is overloaded. 2. Reduce torque compensation setting in Pr.07.02. 3. Use the next higher power AC motor drive model.
OL1	Overload 1 Internal electronic overload trip	<ol style="list-style-type: none"> 1. Check for possible motor overload. 2. Check electronic thermal overload setting. 3. Use a higher power motor. 4. Reduce the current level so that the drive output current does not exceed the value set by the Motor Rated Current Pr.07.00.
OL2	Overload 2 Motor overload.	<ol style="list-style-type: none"> 1. Reduce the motor load. 2. Adjust the over-torque detection setting to an appropriate setting (Pr.06.03 to Pr.06.05).
HPF1	CC (current clamp)	Return to the factory.
HPF2	OV hardware error	
HPF3	GFF hardware error	
HPF4	OC hardware error	
bb	External Base Block. (Refer to Pr. 08.07)	<ol style="list-style-type: none"> 1. When the external input terminal (B.B) is active, the AC motor drive output will be turned off. 2. Deactivate the external input terminal (B.B) to operate the AC motor drive again.
ocA	Over-current during acceleration	<ol style="list-style-type: none"> 1. Short-circuit at motor output: Check for possible poor insulation at the output lines. 2. Torque boost too high: Decrease the torque compensation setting in Pr.07.02. 3. Acceleration Time too short: Increase the Acceleration Time. 4. AC motor drive output power is too small: Replace the AC motor drive with the next higher power model.
ocd	Over-current during deceleration	<ol style="list-style-type: none"> 1. Short-circuit at motor output: Check for possible poor insulation at the output line. 2. Deceleration Time too short: Increase the Deceleration Time. 3. AC motor drive output power is too small: Replace the AC motor drive with the next higher power model.
ocn	Over-current during constant speed operation	<ol style="list-style-type: none"> 1. Short-circuit at motor output: Check for possible poor insulation at the output line. 2. Sudden increase in motor loading: Check for possible motor stall. 3. AC motor drive output power is too small: Replace the AC motor drive with the next higher power model.
EF	External Fault	<ol style="list-style-type: none"> 1. When multi-function input terminals (MI3-MI9) are set to external fault, the AC motor drive stops output U, V and W. 2. Give RESET command after fault has been cleared.
cF10	Internal EEPROM can not be programmed.	Return to the factory.
cF11	Internal EEPROM can not be programmed.	Return to the factory.
cF20	Internal EEPROM can not be read.	<ol style="list-style-type: none"> 1. Press RESET key to set all parameters to factory setting. 2. Return to the factory.
cF21	Internal EEPROM can not be read.	<ol style="list-style-type: none"> 1. Press RESET key to set all parameters to factory setting. 2. Return to the factory.
cF30	U-phase error	Return to the factory.
cF31	V-phase error	
cF32	W-phase error	
cF33	OV or LV	
cF34 cF35	Temperature sensor error	

Fault Name	Fault Descriptions	Corrective Actions
<i>GFF</i>	Ground fault	When (one of) the output terminal(s) is grounded, short circuit current is more than 50% of AC motor drive rated current, the AC motor drive power module may be damaged. NOTE: The short circuit protection is provided for AC motor drive protection, not for protection of the user. 1. Check whether the IGBT power module is damaged. 2. Check for possible poor insulation at the output line.
<i>cFR</i>	Auto accel/decel failure	1. Check if the motor is suitable for operation by AC motor drive. 2. Check if the regenerative energy is too large. 3. Load may have changed suddenly.
<i>cE--</i>	Communication Error	1. Check the RS485 connection between the AC motor drive and RS485 master for loose wires and wiring to correct pins. 2. Check if the communication protocol, address, transmission speed, etc. are properly set. 3. Use the correct checksum calculation. 4. Please refer to group 9 in the chapter 5 for detail information.
<i>codeE</i>	Software protection failure	Return to the factory.
<i>RErrr</i>	Analog signal error	Check the wiring of ACI
<i>FbE</i>	PID feedback signal error	1. Check parameter settings (Pr.10.01) and AVI/ACI wiring. 2. Check for possible fault between system response time and the PID feedback signal detection time (Pr.10.08)
<i>PHL</i>	Phase Loss	Check input phase wiring for loose contacts.
<i>AUE</i>	Auto Tuning Error	1. Check cabling between drive and motor 2. Retry again
<i>CP10</i>	Communication time-out error on the control board or power board	1. Press RESET key to set all parameters to factory setting. 2. Return to the factory.
<i>PtC1</i>	Motor overheat protection	1. Check if the motor is overheat
<i>PtC2</i>		2. Check Pr.07.12 to Pr.07.17 settings
<i>PGEr</i>	PG signal error	1. Check the wiring of PG card 2. Try another PG card
<i>COUd</i>	CANopen Guarding Time out (Only for VFDxxxExxC)	Connect to CAN bus again and reset CAN bus
<i>CHbt</i>	CANopen Heartbeat Time out (Only for VFDxxxExxC)	Connect to CAN bus again and reset CAN bus
<i>CSYc</i>	CANopen SYNC Time out (Only for VFDxxxExxC)	Check if CANopen synchronous message is abnormal
<i>CSdo</i>	CANopen SDO Time out (Only for VFDxxxExxC)	Check if command channels are full
<i>CSbF</i>	CANopen SDO buffer overflow (Only for VFDxxxExxC)	1. Too short time between commands, please check SDO message sent from the master 2. Reset CAN bus
<i>cbSF</i>	CAN bus off (Only for VFDxxxExxC)	1. Check if it connects to terminal resistor 2. Check if the signal is abnormal 3. Check if the master is connected
<i>cbtU</i>	CAN Boot up fault (Only for VFDxxxExxC)	1. Check if the master is connected 2. Reset CAN bus
<i>CPto</i>	Error communication protocol of CANopen (Only for VFDxxxExxC)	Check if the communication protocol is correct
<i>dEb</i>	It will be displayed during deceleration when Pr.08-24 is not set to 0 and unexpected power off occurs, such as momentary power loss.	1. Set Pr.08-24 to 0 2. Check if the input power is stable
<i>AcL</i>	Abnormal Communication Loop	1. Check if the communication wiring is correct 2. Return to the factory

9 THE OPERATION CYCLE

Before operating all the main parts of the machine must be set to optimum conditions (see the chapter on “regulating the machine”)

9.1 Miter Angle

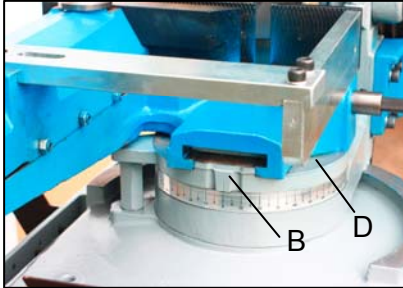

- Use the miter lock lever (A) to release the disk head assembly.
- Rotate the disk head assembly to the correct miter angle.
- Check the miter angle on the angle indicator (B) below the vise
- Use the miter lock lever (A) to lock in the miter angle.

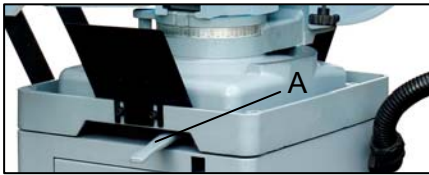

9.2 Vise Operation

The quick clamp vise lever allows the operator to quickly clamp and unclamp work-pieces of same width. This allows for efficient use of machine for loading and feeding forward work-pieces.

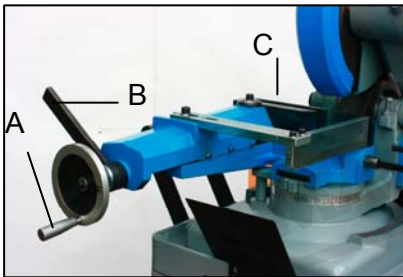

Use the hand wheel to open and close the vise jaw for work pieces that vary in width.

- Rotate the hand-wheel (A) counter-clockwise to open the vise.
- Rotate the hand-wheel (A) clockwise to close and approach the vise jaw (C) to the work pieces.

Use the vise lever to quickly clamp and unclamp work pieces of the same width.

- Rotate the vise lever (B) clockwise to clamp the work-piece.
- Rotate the vise lever (B) counter-clockwise to unclamp the work-piece.

The clamping vise set equips with the function to adjust forward and backward for extending the clamp capacity.

There is a sliding devise between the swing base and the bottom of the vise. Please refer to the indicator on picture (9.1 D).

- Pull out the vise set that the entire vise ti come out and vice versa.

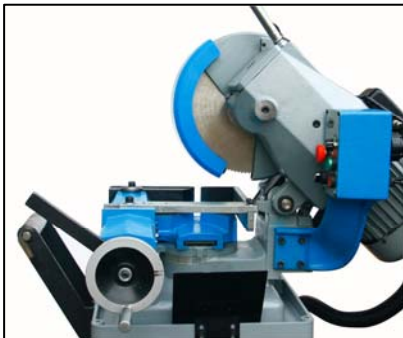

The clamping vise equips with another function for making the slot cutting in the head was set in 90 degree.

- Take off the set of bar stop of setting cutting measurement. Use a hex wrench 5mm to loss the M6x10 screw on the long rod (Q-6.3 pic.-9).
- Loosen the miter lock lever (9.1 A).
- Rotate the entire head unit to the right, checking the angle on the indicator (9.1, B) at the 90 degree of vise.
- Upload the material and clamp it securely before cutting.

9.3 Loading the Work-piece

- Use the vise hand-wheel to open the vise wider than the width of the work-piece.
- Measure and mark off the length of material desired to be cut-off.
- Place the work-piece on the flat surface in between the vise jaws.
- Slide the work-piece across the vise so that the length mark lines up with the blade or disk.
- Press the work-piece up against the back vise jaw.
- Use the vise hand-wheel to clamp the work-piece.

If repetitive cuts are required for material of the same width:

- Use the vise hand-wheel to approach the work-piece, but leave an approximate 5mm gap between the mobile vise jaw and the work-piece.
- Then use the vise lock lever to clamp and unclamp the work-piece.

Decrease vibration (workpiece position setting)

The clamping vise can be adjusted forward and backward to clamp work-piece for various size.

Please be followed the trick as below when loading (setting) the work-piece position for decreasing the vibration.

1. check the workpiece's center not over the center of blade. Please see drew A
- 2.

9.4 Setting Cutting Length

Setting the cutting length removes the need to repeatedly measure work-pieces for repetitive cuts of a single length.

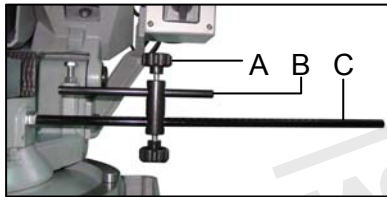

- Measure and mark off the length of material desired to be cut-off.
- Load the work-piece.
- Line up the cut
- Clamp the work-piece.
- Loosen the hex nut at the base of the bar riser (A).
- Slide the bar riser (A) along the long rod (C) so that the tip of stop bar (B) touches the end of the work-piece.
- Tighten the hex nut at the base of the bar riser (A).

The stop bar in use

- Cut off the first length of work-piece.
- Unclamp the work-piece
- Slide the work-piece forward until it reaches tip of the stop bar (A).
- Clamp the work-piece.
- Then proceed with the operation cycle

9.5 Operation Cycle

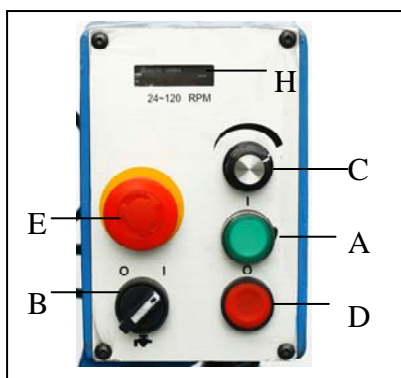

- Set the miter cut angle, if necessary
- Open the vise, if necessary
- Load the work-piece
- Clamp the work-piece
- Adjust the bar stop for cutting length, if necessary
- Check that the main power light is ON (A).
- Set the speed (C), read the speed displayed on the window (H).

- Set the coolant switch (B).
- Grasp the control handle (G).
- Press the trigger switch (F) to start.
- Pull down the control handle (G). Apply a steady and constant pressure.

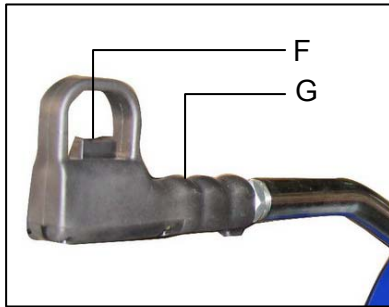

- After cut off
- Raise control handle slowly
- Press the stop button (D)
- Use vise lever to open the vise
- Remove or feed the work-piece forward
- Repeat operation cycle, if necessary

The chopper is now ready to start work, bearing in mind that the CUTTING SPEED and the TYPE of DISC – combined with a suitable descent of the head – are of decisive importance for cutting quality and for machine performance.

When starting to cut with a new disk, in order to safeguard its life and efficiency, the first two or three cuts must be made while exerting a slight pressure on the part, so that the time taken to cut is about double the normal time.

Press the red emergency button (E) when there are conditions of danger of malfunctions in general, so as to stop machine operation immediately.

10 ROUTINE AND SPECIAL MAINTENANCE

THE MAINTENANCE SCHEDULE AS BEEN DIVIDED INTO DAILY, WEEKLY, MONTHLY, AND SIX-MONTHLY INTERVALS. NEGLECTING THE MACHINE MAINTENANCE WILL RESULT IN PREMATURE WEAR AND POOR PERFORMANCE.

10.1 Daily Maintenance

Make a general cleaning by removing dust and shavings from the machine.

Top off the coolant.

Inspect the disk/saw blade for wear.

Raise the head into a high position to reduce stress on the return spring.

Check that the shields and emergency stops are in good working order.

10.2 Weekly Maintenance

Thoroughly clean the machine including the coolant tank.

Clean and grease the vice screw and sliding surfaces.

Clean the housing for disk/saw blade.

Sharpen the saw teeth.

10.3 Monthly Maintenance

Check that all screws on the motor, the pump, the vise jaws, and the guard are tight and secure.
Check that the guard is free from defect.
Grease the hinge pin for the head assembly.

10.4 Six-Monthly Maintenance

Change the oil in the reduction unit using oil type DN SUPER GEAR 460 by IDEMITSU or DAPHON or equivalent oil, proceeding as follows:

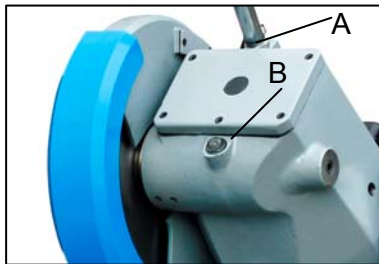

Remove the connecting plug from the electric box and unscrew the control handle.
Drain off the old oil from the drain hole (B)
Pour in new oil of to the mark (A), through the hole for the control handle, keeping head in a horizontal position.
Full the oil up at least 1.5 liters.
Reassemble all the parts.
Check continuity of the equipotential protection circuit.

10.5 Oils for Lubricating Coolant

Considering the vast range of products on the market, the user can choose the one most suited to his own requirements, using as reference the type SHELL LUTEM OIL ECO.
THE MINIMUM PERCENTAGE OF OIL DILUTED IN WATER IS 8~10%.

10.6 Oil Disposal

Oil products must be disposed in a proper manner following local regulations. Please refer to "Machine disposal."

10.7 Special Maintenance

Special maintenance operations must be carried out by skilled personnel. However, we advise contacting dealer and/or importer the term special maintenance also covers the resetting of protection and safety equipment and devices.

11 TROUBLESHOOTION

This chapter lists the probable faults and malfunctions that could occur while the machine is being used and suggests possible remedies for solving them.

The first paragraph provides diagnosis for TOOLS and CUTS, the second for ELECTRICAL COMPONENTS.

11.1 Blade and cut diagnosis

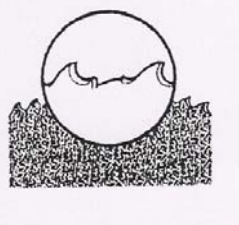
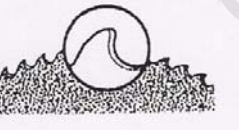
FAULT	PROBABLE CAUSE	REMEDY
<p>TOOTH BREAKAGE</p> 	<p>Too fast advance</p> <p>Wrong cutting speed</p> <p>Wrong tooth pitch</p> <p>Low quality disk</p> <p>Ineffective gripping of the part in the vise.</p> <p>Previously broken tooth left in the cut.</p> <p>Cutting resumed on a groove made previously.</p> <p>Insufficient lubricating refrigerant or wrong emulsion.</p> <p>Sticky accumulation of material on the disk.</p>	<p>Decrease advance, exerting less cutting pressure.</p> <p>Change disk speed and/or diameter.</p> <p>See chapter "Material classification and choice of disks" and the Table of cutting speeds according to disk diameter.</p> <p>Choose a suitable disk.</p> <p>See chapter "Material classification and choice of disks".</p> <p>Use a better quality disk.</p> <p>Check the gripping of the part.</p> <p>Accurately remove all the parts left in.</p> <p>Make the cut elsewhere, turning the part.</p> <p>Check the level of the liquid in the tank.</p> <p>Increase the flow of lubricating refrigerant, checking that the hole and the liquid outlet pipe are not blocked.</p> <p>Check the blend of lubricating coolant and choose a better quality disk.</p>
<p>PREMATURE DISK WEAR</p> 	<p>Wrong running in of the disk .</p> <p>Wrong cutting speed.</p> <p>Unsuitable tooth profile.</p> <p>Wrong tooth pitch.</p> <p>Low quality disk.</p> <p>Insufficient lubricating refrigerant.</p>	<p>See chapter "Material classification and choice of disks" in the paragraph on Running in the disk.</p> <p>Change disk speed and / or diameter.</p> <p>See Chapter "Material classification and choice of disks" and the Table of cutting speeds according to disk diameter.</p> <p>Choose a suitable disk. See Chapter "Material classification and choice of disks" in the paragraph on Type of disks.</p> <p>Choose a suitable disk.</p> <p>See Chapter "Material classification and choice of disks".</p> <p>Use a better quality disk.</p> <p>Check the level of the liquid in the tank.</p> <p>Increase the flow of lubricating refrigerant, checking that the hole and the liquid outlet pipe are not blocked.</p>

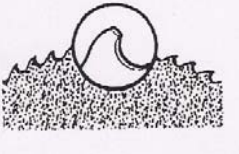
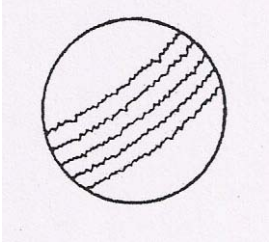
FAULT	PROBABLE CAUSE	REMEDY
<p>CHIPPED DISK</p> 	<p>Hardness, shape or flaws in the material (oxides, inclusions, lack of homogeneity, etc...) Wrong cutting speed.</p> <p>Wrong tooth pitch.</p> <p>Vibrations Disk incorrectly sharpened. Low quality disk.</p> <p>Incorrect emulsion of the lubricating Refrigerant.</p>	<p>Reduce the cutting pressure and/or the advance.</p> <p>Change disk speed and/or diameter. See Chapter "Material classification and choice of disks" and the Table of cutting speeds according to disk diameter. Choose a suitable disk. See Chapter "Material classification and choice of disks". Check gripping of the part. Replace the disk with one that is more suitable and correctly sharpened. Use a better quality disk. Check the percentage of water and oil in the emulsion.</p>
<p>DISK VIBRATION</p>	<p>Wrong tooth pitch.</p> <p>Unsuitable tooth profile.</p> <p>Ineffective gripping of the part in the vise.</p> <p>Dimensions of the solid section too large with respect to the maximum admissible cutting dimensions. Disk diameter incorrect and/or too large.</p>	<p>Choose a suitable disk. See Chapter "Material classification and choice of disks". Choose a suitable disk. See Chapter "Material classification and choice of disks" in the paragraph on Type of disks. Check the gripping of the part.</p> <p>Abide by the instructions.</p> <p>Decrease the disk diameter, adapting it to the dimensions of the part to be cut, the cutting part of the disk must not be too large for the shape of the part to be cut.</p>
<p>RIDGES ON THE CUTTING SURFACE</p> 	<p>Disk diameter incorrect and/ or too large.</p> <p>Ineffective gripping of the part in the vise. Too fast advance.</p> <p>Disk teeth are worn. Insufficient lubricating refrigerant.</p> <p>Toothing does not unload shavings well.</p>	<p>Decrease the disk diameter, adapting it to the dimensions of the part to be cut, the cutting part of the disk must not be too large for the shape of the part to be cut. Check the gripping of the part.</p> <p>Decrease advance, exerting less cutting pressure. Sharpen the tool. Check the level of the liquid in the tank. Increase the flow of lubricating refrigerant, checking that the hole and the liquid outlet pipe are not blocked. Choose a blade with a larger tooth pitch that allows better unloading of shavings and that holds more lubricating refrigerant.</p>

FAULT	PROBABLE CAUSE	REMEDY
<p>CUT OFF THE STRAIGHT</p>	<p>Too fast advance. Ineffective gripping of the part in the vise. Disk head off the straight. Disk sides differently sharpened. Disk thinner than the commercial standard. Dirt on the gripping device.</p>	<p>Decrease advance, exerting less cutting pressure. Check the gripping of the part which may be moving sideways. Adjust the head. Choose tool quality carefully in every detail as regards type and construction characteristics. Carefully clean the laying and contact surfaces.</p>
<p>BLADE STICKS IN THE CUT</p> 	<p>Too fast advance. Low cutting speed. Wrong tooth pitch. Sticky accumulation of material on the disk. Insufficient lubricating refrigerant.</p>	<p>Decrease advance, exerting less cutting pressure. Increase speed. Choose a suitable disk. See Chapter "Material classification and choice of disks". Check the blend of lubricating coolant and choose a better quality disk. Check the level of the liquid in the tank. Increase the flow of lubricating refrigerant, checking that the hole and the liquid outlet pipe are not blocked.</p>

MACHINERYHOUSE

12 WIRING DIAGRAM AND PARTS LIST

12.1 WIRING DIAGRAM

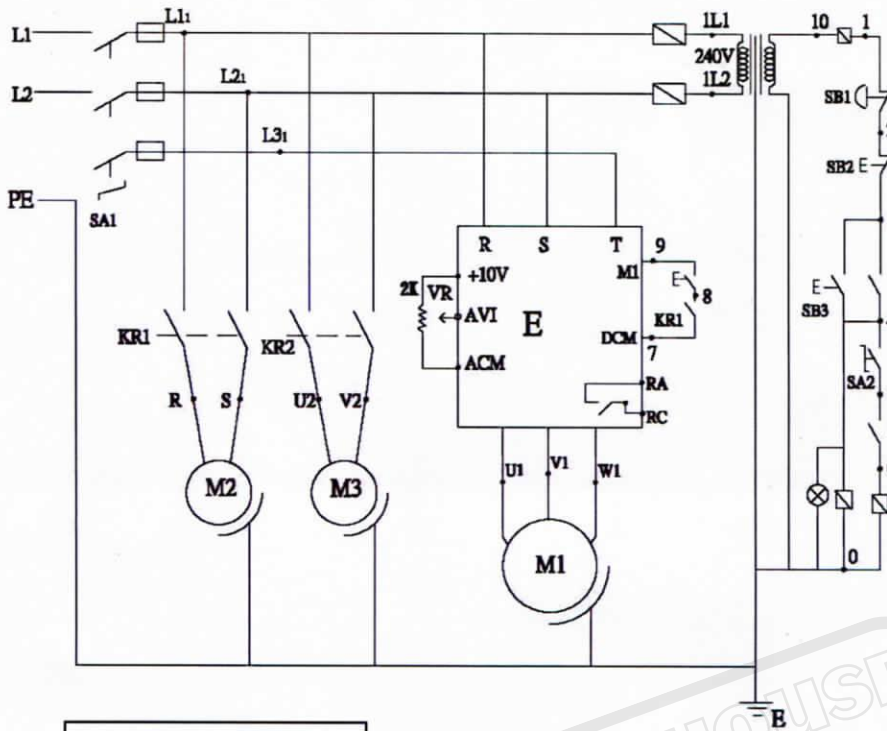

20 AMP CIRCUIT

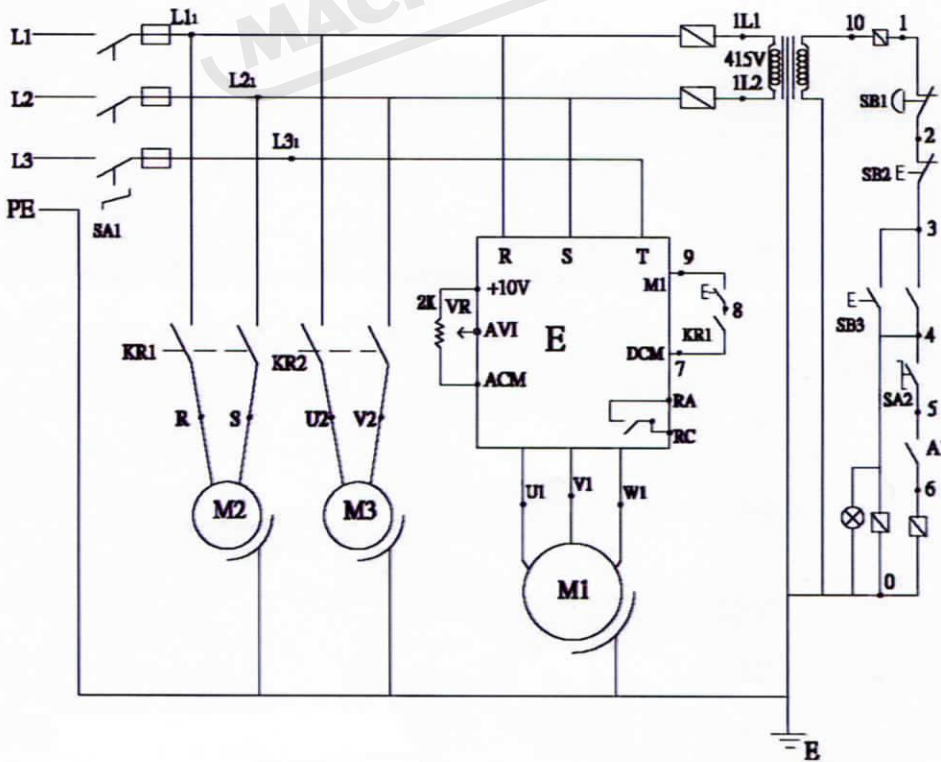

12.2 PARTS LIST

Item name	Description and function	Technical data	Quantity	Supplier	Suppliers reference	Remarks
F 1 F 2 F 3	Fuses Fuses base	30x6.2mm 250V 0.5A 0.5A 1A 10A 1P	1 1 1 3	BOSSING CHIA WEI	JMC-63 FSB-104	ROHS
KR 1 KR 2	Relay	250VAC 5A	1 1	BETA	AC 24V BMY-5-4C-5 BMY-5-2C-5	CE CSA
A1	Variable speed AC Motor driver	460V 4A 230V 7A 2.2KW	1	DALTA	022E43 022E21	CE
TC	Transformer	35VA 230/24V ,400V/24V	1	TAI CHUNG	# 57	
SB1	Emergency Stop	250V 6A	1	KEYON	SKB2-BS542	CE CUS
SB2 SB3	Stop button Start button	250V 6A	1 1	N.H.D.	24V NPB-22-F-1B NLB-22-F-G1A	CE CUS
SB4	Trigger switch	15A 1/2HP 125 250VAC 0.6A 125VDC 0.3A 250VDC	1	OMRON	V-15-1A5	CE CUS
SA1	Main switch	16A440VAC	1	KEDU	ZH-C316	CE
SA2	Pump switch	250V	1	N.H.D.	NSS-22-S2-1A	CE CUS
VR	Adjust-speed switch	5K Ω Max.	1	TOCOS	RVT24YNM 20SB502	JIS
M1	Motor	400V,230V/ (2.2kw) 3HP 3ph	1	KAI SHEN		
M2	Motor Fan (Ventilator)	220~240V 0.12 / 0.11A 380~400V 0.06 / 0.07A 415~460V 0.07 / 0.05A	1	KAKU	KA1238HA2SAT KA1238HA3 KA1238HA4	IP55 CE
M3	Coolant pump	400V / 3ph, 230V/1PH (0.09kw) 1/8HP	1	KAI SHEN		

12.3 Explosion draw

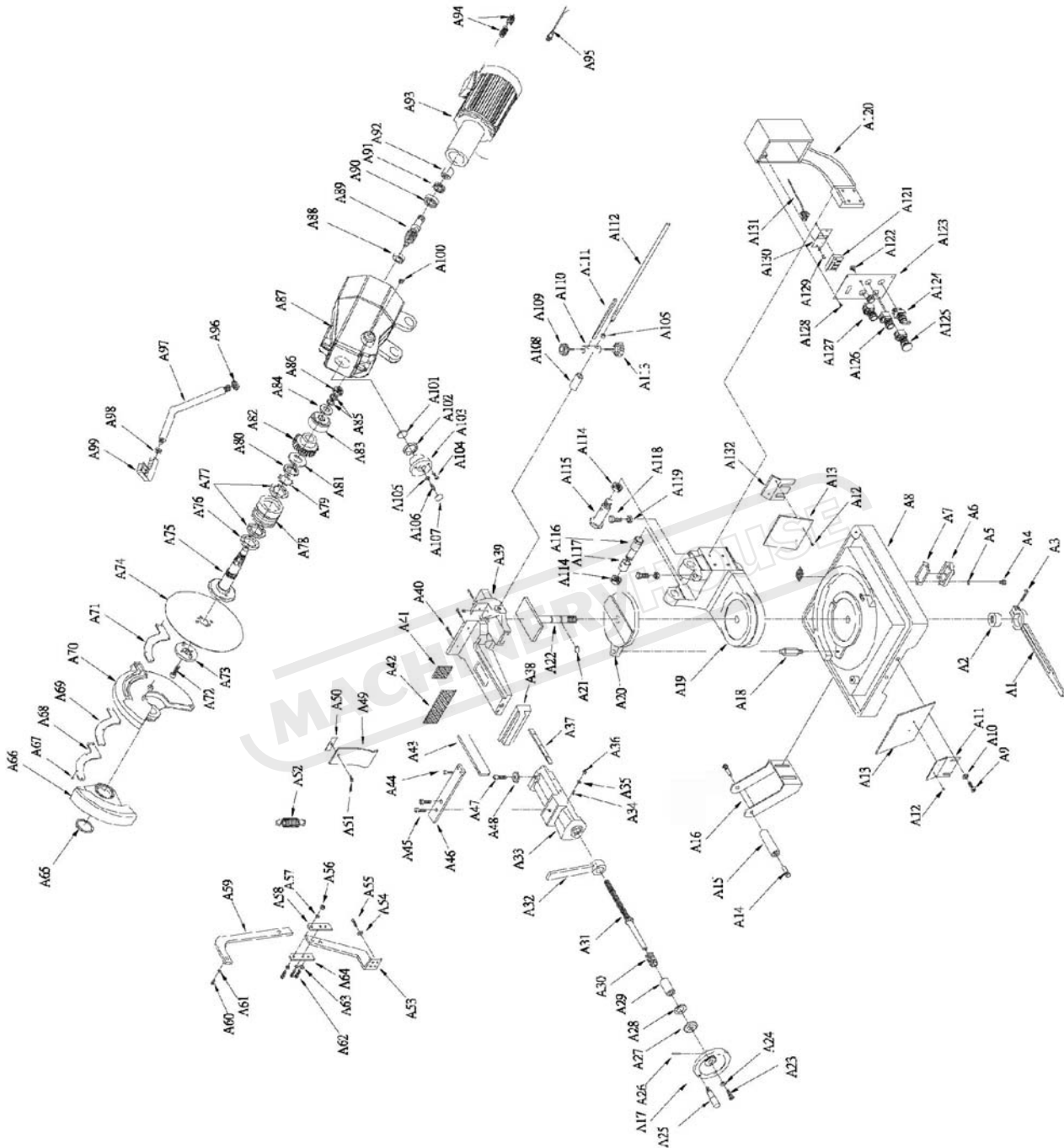

12.4 Parts List- Part A

Index NO.	Description	Size	Q'TY	Index NO.	Description	Size	Q'TY
A1	Lock handle		1	A39	Vise bench		1
A2	Lock Nut		1	A40	Hex socket cap screw	M5x25	3
A3	Hex socket cap screw		1	A41	Small grooved jaw		1
A4	Hex socket cap screw	M8x25	2	A42	Grooved jaw		1
A5	Washer	5/16"	2	A43	Stopper		1
A6	Drainage		1	A44	Hex socket cap screw	M8x20	2
A7	Rubber		1	A45	Hex socket cap screw	M8x25	2
A8	Base		1	A46	Plate (vise)		1
A9	Hex socket cap screw	M8x16	2	A47	Hex socket cap screw	M8x25	1
A10	Washer	5/16"	2	A48	Washer		1
A11	Support plate		1	A49	Anti-dust plate		1
A12	Screw		2	A50	Holder plate		1
A13	Anti-spray plate		2	A51	Screw		1
A14	Hex head screw		2	A52	Sping		1
A15	Roller		1	A53	Lower switching plate		1
A16	Roller bracket		1	A54	Washer		2
A17	Handle wheel		1	A55	Hex socket cap screw		2
A18	Support rod		1	A56	Nut		1
A19	Swing arm(base)		1	A57	Washer		1
A20	Slide base		1	A58	Joint plate w/thread		1
A21	C-clip		1	A59	Swing handle		1
A22	Center shaft		1	A60	Hex socket cap screw	M6x12	1
A23	Hex socket cap screw	M8x20	1	A61	Washer	1/4"	1
A24	Washer	M10	1	A62	Hex socket cap screw	M8x20	3
A25	Grip		1	A63	Washer	5/16"	2
A26	Set screw		1	A64	Joint plate		1
A27	Bearing cover		1	A65	C-clip		1
A28	Bearing		1	A66	Blade shield		1
A29	Bushing		1	A67	Screw	M5x10	7
A30	Sping		1	A68	Plate (cover)		1
A31	Leading screw		1	A69	Rubber		2
A32	Lock handle		1	A70	Blade cover (casting)		1
A33	Slide vise		1	A71	Plate (cover)		1
A34	Set screw		3	A72	Hex socket cap screw	M12x35	1
A35	Washer		3	A73	Fixing flange		1
A36	Nut		3	A74	Saw blade (optional)	350mm	1
A37	Gib		1	A75	Spindle shaft		1
A38	Vise clamp		1	A76	Oil seal	50.72.8.	1

12.5 Parts List- Part A

Index NO.	Description	Size	Q'TY	Index NO.	Description	Size	Q'TY
A77	Taper roller	32008	2	A112	Lower length setting rod		1
A78	Spindle sleeve		1	A113	Lock bolt with knob		1
A79	Star washer		1	A114	Locking nut		2
A80	Locking nut		1	A115	Shaft (right)		1
A81	Spacer		1	A116	Shaft (left)		1
A82	Worm gear		1	A117	Bushing		1
A83	Bushing		1	A118	Hex head screw		2
A84	Plate, stopper		1	A119	Nut		2
A85	Disc spring washer		2	A120	Control arm		1
A86	Locking nut		1	A121	Digital display		1
A87	Machine head		1	A122	Speed control knob		1
A88	Ball bearing	6301	1	A123	Control panel		1
A89	Worm shaft		1	A124	Pump selection switch		1
A90	Ball bearing	5305	1	A125	Emergency switch		1
A91	Oil seal	25x52x10	1	A126	Start button		1
A92	Coupling		1	A127	Stop button		1
A93	Motor	3HP	1	A128	Screw		4
A94	Wire relief		2	A129	Hex socket cap screw		2
A95	Control wire		1	A130	Support plate		1
A96	Nut	M20	1	A131	Transmission wire		1
A97	Control handle rod		1	A132	Support plate, rear		1
A98	Nut	M16	1				
A99	Handle with trigger switch		1				
A100	Oil pilot		1				
A101	Gasket		1				
A102	Oil ring	5x55	2				
A103	Casting plug		1				
A104	Hex socket cap screw	M6x20	3				
A105	Nut	M10	1				
A106	Set screw	M10x35	1				
A107	Oil seal		1				
A108	Bushing for length setting rod		1				
A109	Lock bolt with knob	5x55	1				
A110	Bracket, length setting		1				
A111	Upper length setting rod		1				

12.6 Explosion draw

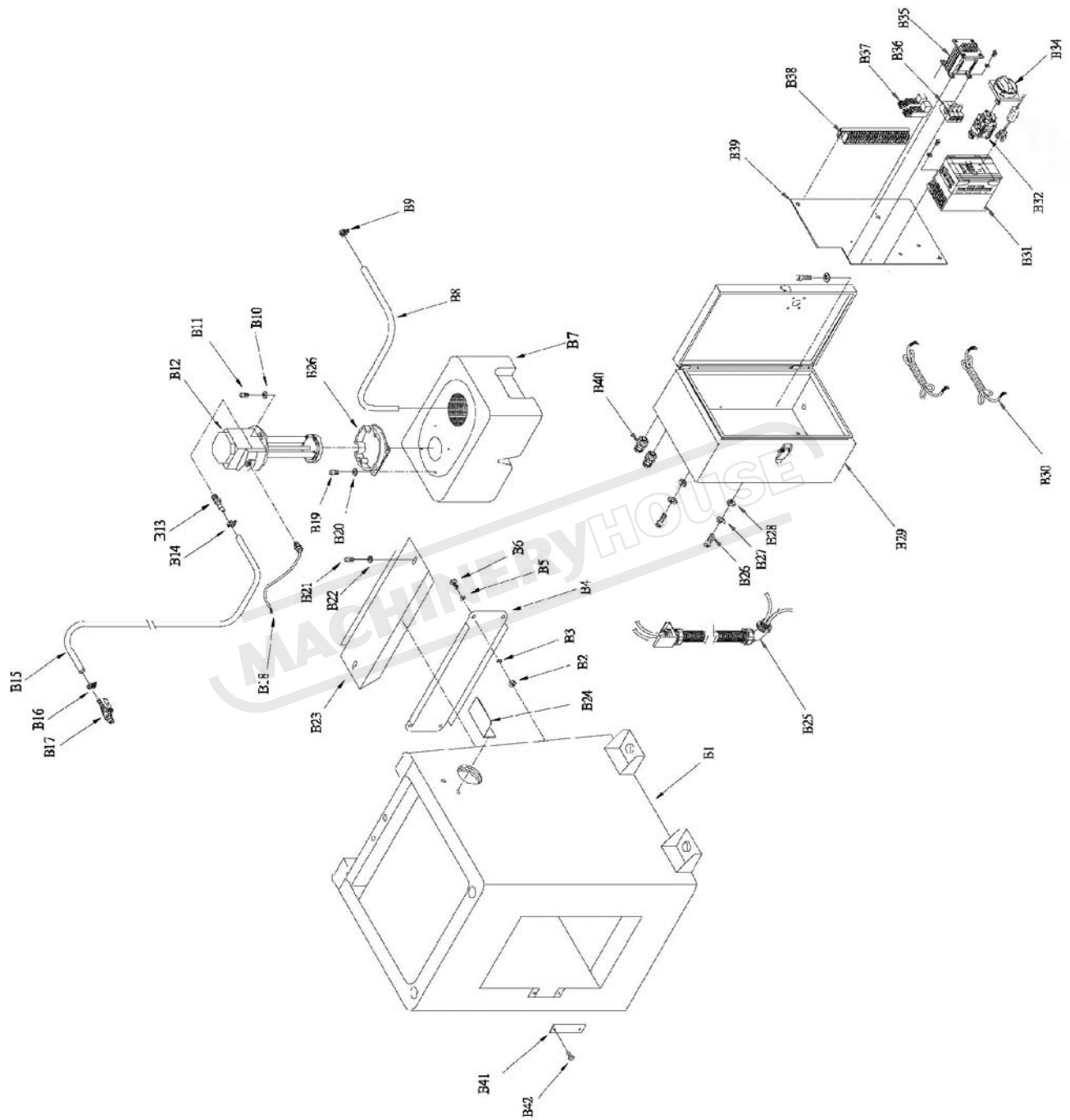

12.7 Parts List- Part B

Index NO.	Description	Size	Q'TY
B1	Stand,		1
B2	Nut	M6	4
B3	Washer	1/4"	4
B4	Suppot plate		1
B5	Washer	1/4"	4
B6	Hex cap screw	M6x15	4
B7	Coolant tank		1
B8	Hose		1
B9	Hose clamp		1
B10	Washer	1/4"	2
B11	Hex socket cap screw	M6x16	2
B12	Coolant pump		1
B13	Hose connector		1
B14	Hose clamp		1
B15	Hose	3/8"	1
B16	Hose clamp		1
B17	Valve		1
B18	Pump wire		1
B19	Hex cap screw	M6x15	4
B20	Washer	1/4"	4

Index NO.	Description	Size	Q'TY
B21	Hex cap screw	M6x15	2
B22	Washer	1/4"	2
B23	Suppot plate for tank		1
B24	Protector, plate		1
B25	Gooseneck tube		1
B26	Hex cap screw		4
B27	Washer		4
B28	Nut		4
B29	Electrical box		1
B30	Power cord		1
B31	Inverter		1
B32	Safety door switch		1
B35	Transformer		1
B36	Fuse and fuse base		1
B37	Relay		2
B38	Terminal plate		1
B39	Circuit board		1
B40	Wire relief		2
B41	Screw		2
B42	Plate, cover		1